

REV	ECH #	DESCRIPTION	DRAWING	APPROVED	DATE
A		NEW RELEASE	DEV1		2012/05/25

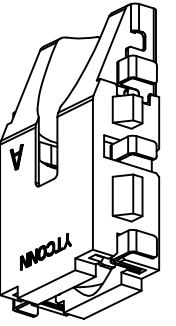

- NOTES:
1. CONTACT CURRENT RATING: 1A.
  2. CONTACT RESISTANCE: 50 mΩ MAX.;
  3. INSULATION RESISTANCE: 1000 Ω MIN.;
  4. DIELECTRIC WITHSTANDING: 500V AC MIN.;
  5. DURABILITY: 5,000 CYCLES MIN.;
  6. CONNECTOR MATING FORCES: 29.4N (3.00kgf) MAX.;
  7. CONNECTOR UNMATING FORCES: 2.94N(O.30kgf) MIN.;

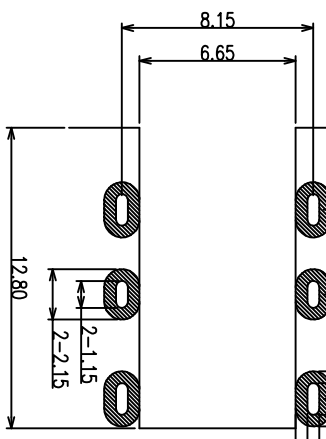
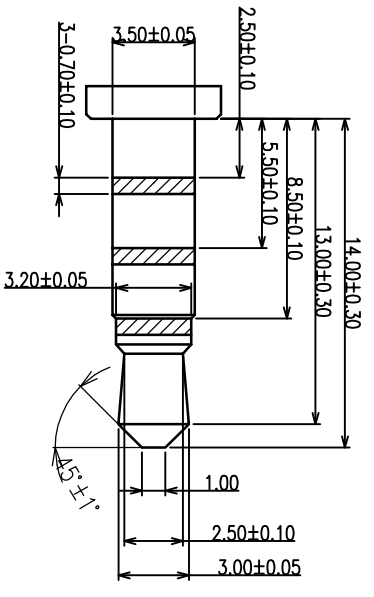
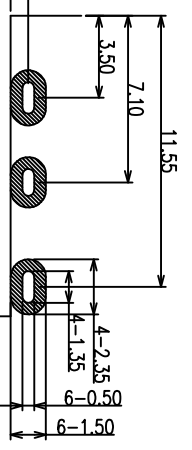
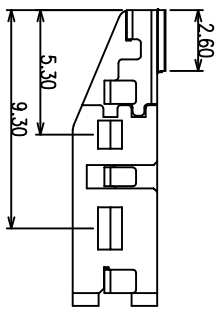
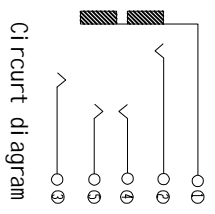
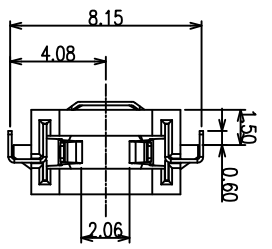
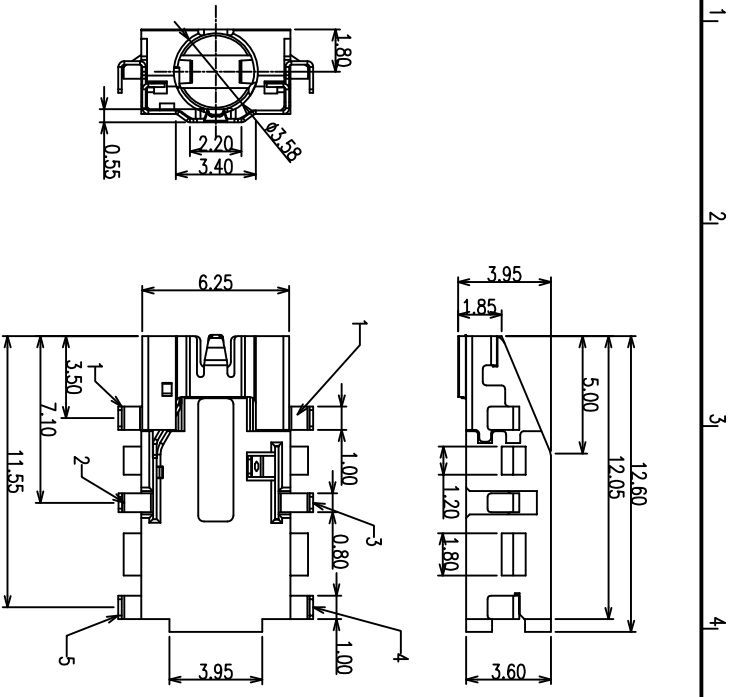

PRODUCT NO.

PJ23-05 A B 03-00

① ② ③ ④

① PRODUCT SERIES:  
PJ23: PHONE JACK CONNECTOR.

② PIN NO. :

05: 5PIN

③ MATERIAL:

A: PA9T

④ SERIES NO. :

00:斜口,沉板1.5H

**CUSTOMER DRAWING**

**YTCONN**  
Dongguan YTCONN Electronics Technology Co., Ltd

GENERAL TOLERANCE	DRAWING	DEV1	TITLE:	PHONE JACK CONNECTOR沉板1.5H斜口
X ±0.20	APPROVED		P/N:	PJ23-05AB03-00
.XX ±0.15	DATE	2013.07.18	DRAWING NO.	C-PJ23-00
.XXX ±0.10	UNIT	mm	SCALE	1:1
ANGEL TOLERANCE	SIZE	A4	SHEET	1of1
X ±5°	REV	A		
.XX ±2°				
.XXX ±1°				

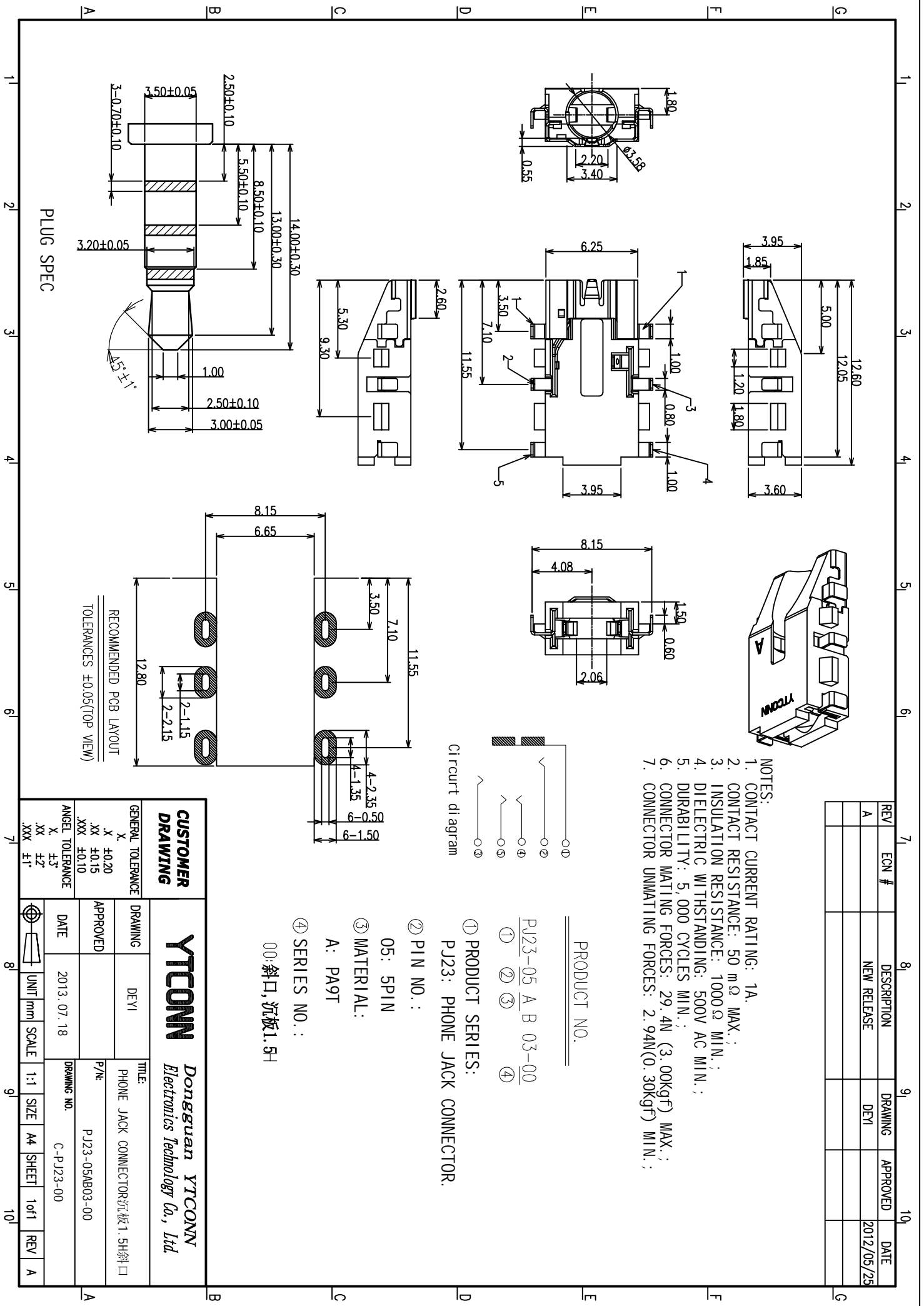

PLUG SPEC