

REV	EON #	DESCRIPTION	DRAWING	APPROVED	DATE
A		NEW RELEASE	DEY1		04/26/12

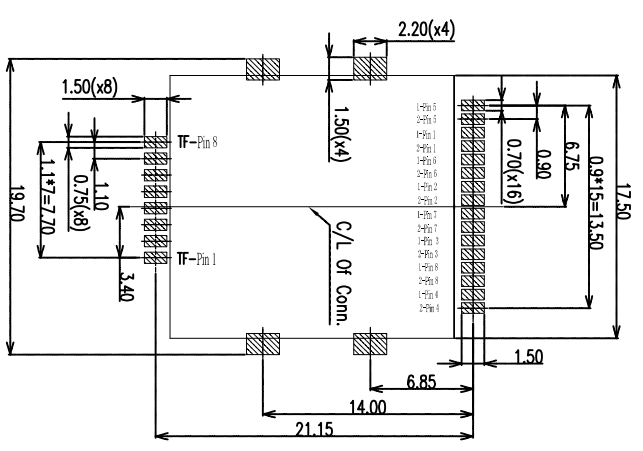

RECOMMENDED PCB LAYOUT
TOLERANCES ±0.05(TOP VIEW)

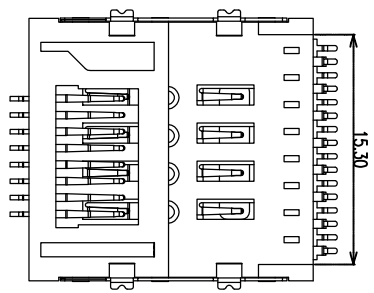
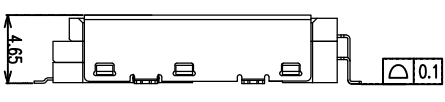
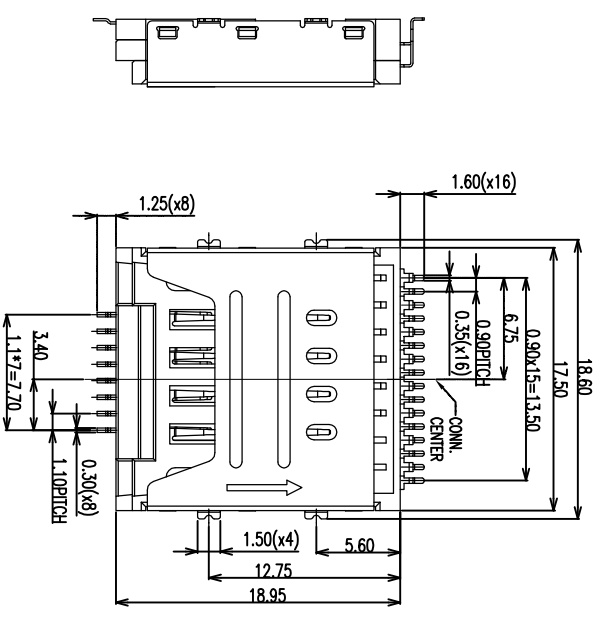
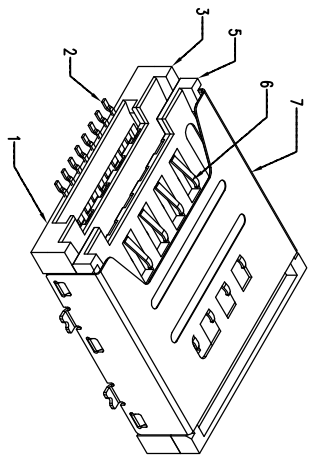

ITEM	NAME	QTY	MATERIAL / FINISH
7	SHELL	1	STAINLESS STEEL/SOLDER TAIL GOLD PLATED
6	UPPER SIM CONTACT	8	COPPER ALLOY/CONTACT AREA GOLD PLATED
5	UPPER SIM HOUSING	1	HIGH TEMPERATURE UL 94-V0 BLACK
4	INNER SIM CONTACT	8	COPPER ALLOY/CONTACT AREA GOLD PLATED
3	UNDER SIM HOUSING	1	HIGH TEMPERATURE UL 94-V0 BLACK
2	I-FLASH CONTACT	8	COPPER ALLOY/CONTACT AREA GOLD PLATED
1	I-FLASH HOUSING	1	HIGH TEMPERATURE UL 94-V0 BLACK

CUSTOMER DRAWING
YTCONN
Dongguan YTCONN Electronics Technology Co., Ltd.
<http://www.ytconn.com>

GENERAL TOLERANCE	DRAWING	DEY1	TITLE	SIM DOUBLE+I-FLASH 4.5H 3INT CARD CONN.
X ±0.20	APPROVED		P/N:	SM27-24AB05-00
.XX ±0.15	DATE	2012.04.26	DRAWING NO.	C-SM27-00
.XXX ±0.10	UNIT	mm	SCALE	1:1
ANGEL TOLERANCE	SIZE	A4	SHEET	1 of 1
X ±3°	REV	A		
.XX ±2°				
.XXX ±1°				

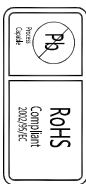

SIM CARD PIN NO.

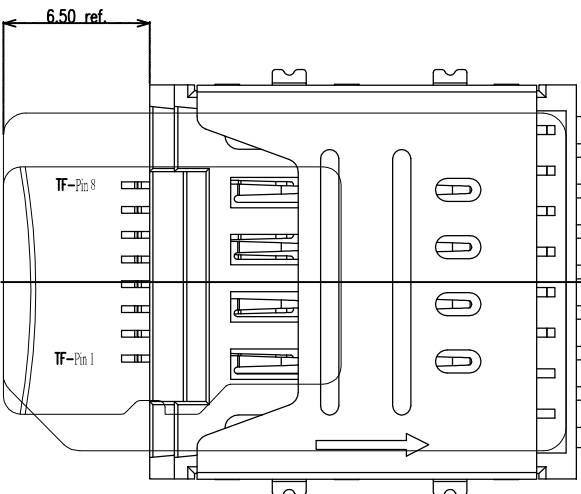
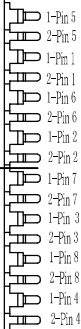

UPPER SIM CARD = SIM 1
 UNDER SIM CARD = SIM 2

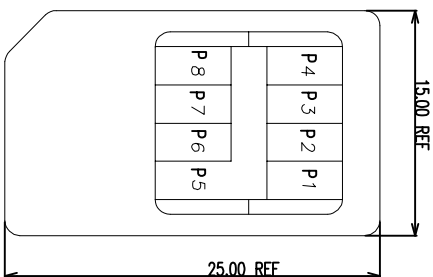

SIM CARD SPEC

NOTES:
 1.MATERIAL
 HOUSING:THERMOPLASTIC,U194Y-0,COLOR:BLACK
 CONTACT:COPPER ALLOY
 SHELL:STAINLESS STEEL
 2.FINISH
 CONTACT: NICKEL UNDERPLANNED AND GOLD PLANTING
 OVER ALL OR TIN PLANTING ON SOLDER AREA
 MAIL: NICKEL UNDERPLANNED AND TIN PLANTING OVER ALL

料号编码

SM27-24 A B 05-00

① ② ③ ④ ⑤

- ① 产品系列:
SM27:SIM DOUBLE+T-FLASH CONNECTOR
- ② 产品PIN数:
24 : 24PIN
- ③ 塑胶材料:
A: LCP
- ④ 塑胶颜色:
B: 黑色
- ⑤ 产品流水号
00:4.5H

TF Card terminal NO.	Pin NO.	SM Card terminal NO.	Pin NO.
Pin 1	DATA LINE BIT2	Pin 1	VCC: PWR signal and GND
Pin 2	CD/DAT3:CARD DETECT/DATA LINE BIT3	Pin 2	RST: Reset signal
Pin 3	CMD: COMMAND/RESPONSE	Pin 3	CLK: Clocking signal
Pin 4	VDD1: SUPPLY VOLTAGE	Pin 4	Reserved
Pin 5	CLK: CLOCK	Pin 5	GND: PWR signal and GND
Pin 6	VSS: SUPPLY VOLTAGE GROUND	Pin 6	VPP: programming Voltage
Pin 7	DAT0: DATA LINE BIT0	Pin 7	IO:serial data input/output
Pin 8	DAT1: DATA LINE BIT1	Pin 8	Reserved

CUSTOMER DRAWING		YTCONN http://www.ytconn.com	
GENERAL TOLERANCE	X	DRAWING	DEY1
ANGEL TOLERANCE	X ±0.20 .XX ±0.15 .XXX ±0.10	APPROVED	P/N:
	X ±3 .XX ±2 .XXX ±1*	DATE	2012.04.26
		DRAWING NO.	C-SM27-00
		UNIT	mm
		SCALE	1:1
		SIZE	A4
		SHEET	2of2
		REV	A

Dongguan YTCONN Electronics Technology Co., Ltd.

SIM DOUBLE+T-FLASH 4.5H 3IN1 CARD CONN.

A

B

C

D

E

F

G

10