

REV	ECON #	DESCRIPTION	DRAWING	APPROVED	DATE
A		NEW RELEASE			

- NOTES:
- CONTACT CURRENT RATING: 1A.
  - CONTACT RESISTANCE: 50 mΩ MAX.;
  - INSULATION RESISTANCE: 1000Ω MIN.;
  - DIELECTRIC WITHSTANDING: 500V AC MIN.;
  - DURABILITY: 5,000 CYCLES MIN.;
  - CONNECTOR MATING FORCES: 29.4N (3.00Kgf) MAX.;
  - CONNECTOR UNMATING FORCES: 2.94N(0.30Kgf) MIN.;
  - PRODUCT MEET THE REQUEST OF THE ROHS, SEE TABLE A:

TABLE A:

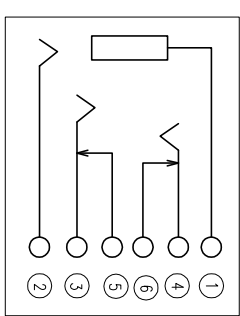

PRODUCT NO.

PJ08-06 A B 05-14

- ①
- ②
- ③
- ④

① PRODUCT SERIES:

PJ08:PHONE JACK CONNECTOR slim 10mm type.

② PIN NO.:

04: 4PIN

06: 6PIN

③ MATERIAL:

A: PA9T

④ SERIES NO.:

14: L=12mm 前后插板中间贴板

**YTCONN**

*Dongguan YTCOONN  
Electronics Technology Co., Ltd.*

**CUSTOMER  
DRAWING**

GENERAL TOLERANCE

X ±0.20

.XX ±0.15

.XXX ±0.10

ANGEL TOLERANCE

X ±5°

.XX ±2°

.XXX ±1°

DRAWING

DEVI

APPROVED

DATE

2013. 06. 05

UNIT

mm

SCALE

1:1

TITLE: PHONE JACK CONNECTOR

slim 10mm L=12 前后插板中间贴板

P/N: PJ08-06AB05-14

DRAWING NO. C-PJ08-14

SHEET 1 of 2

SHEET 1 of 2

REV A

REV A

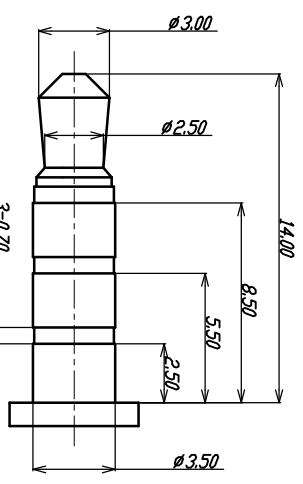
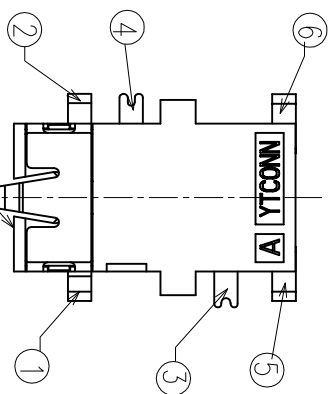
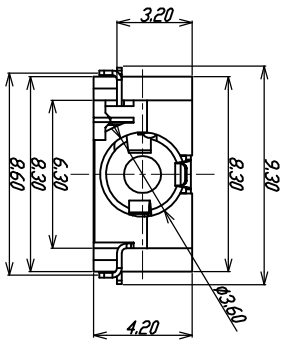
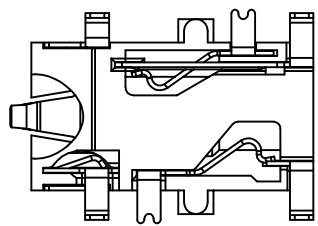
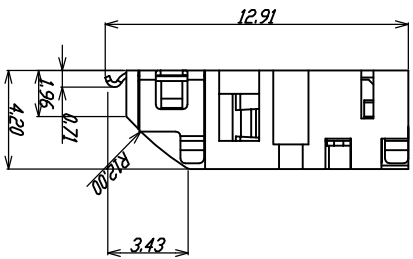
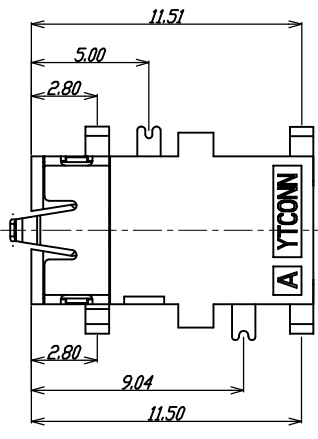

(ø3.50mm 4 POLE PLUG DETAIL DRAWING)

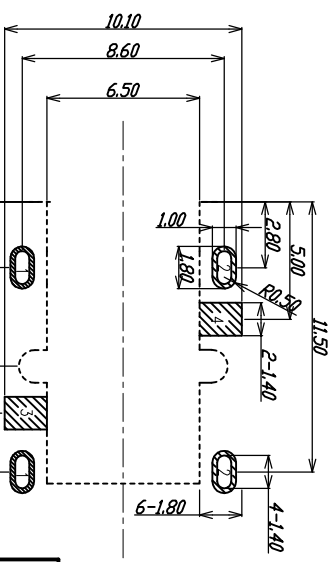

ITEM	PART NAME	QTY	MATERIAL	DESCRIPTION	REMARK
⑦	HOUSING	1	PPA	Gold Flash	Block
⑥	CONTACT F	1	PHOSPHOR BRONZE 0.20T	Gold Flash	
⑤	CONTACT E	1	PHOSPHOR BRONZE 0.20T	Gold Flash	
④	CONTACT D	1	PHOSPHOR BRONZE 0.20T	Gold Flash	
③	CONTACT C	1	PHOSPHOR BRONZE 0.20T	Gold Flash	
②	CONTACT B	1	PHOSPHOR BRONZE 0.20T	Gold Flash	
①	CONTACT A	1	PHOSPHOR BRONZE 0.20T	Gold Flash	