

REV	ECON #	DESCRIPTION	DRAWING	APPROVED	DATE
A		NEW RELEASE			

- NOTES:
- CONTACT CURRENT RATING: 1A.
 - CONTACT RESISTANCE: 50 mΩ MAX.;
 - INSULATION RESISTANCE: 1000Ω MIN.;
 - DIELECTRIC WITHSTANDING: 500V AC MIN.;
 - DURABILITY: 5,000 CYCLES MIN.;
 - CONNECTOR MATING FORCES: 29.4N (3.00Kgf) MAX.;
 - CONNECTOR UNMATING FORCES: 2.94N(0.30Kgf) MIN.;
 - PRODUCT MEET THE REQUEST OF THE ROHS, SEE TABLE A:

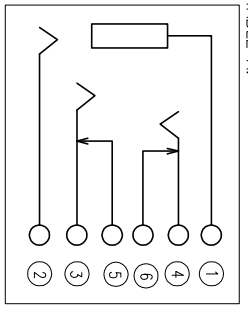

PRODUCT NO.

PJ08-06 A B 05-16
① ② ③ ④

① PRODUCT SERIES:

PJ08:PHONE JACK CONNECTOR slim 10mm type.

② PIN NO.:

04: 4PIN

06: 6PIN

③ MATERIAL:

A: PA9T

④ SERIES NO.:

16:斜口前后插中间贴, 3#锡脚位距离前端9.30mm

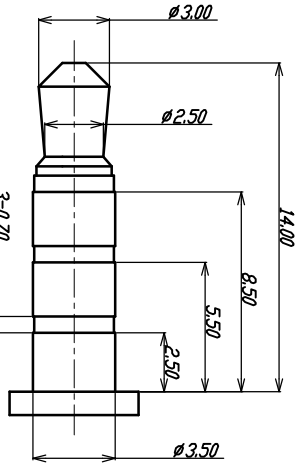
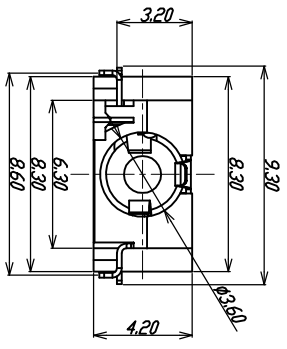
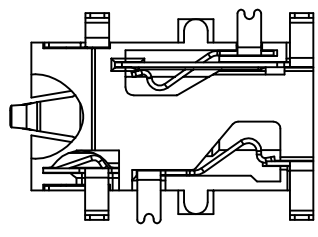
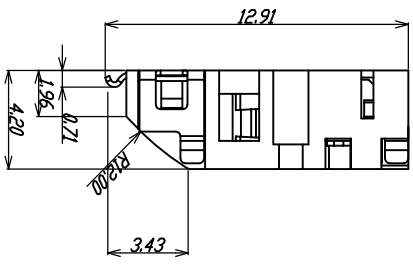
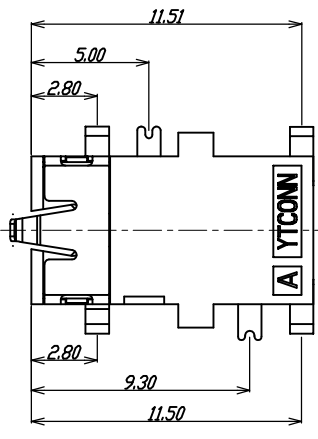

(ø3.50mm 4 POLE PLUG DETAIL DRAWING)

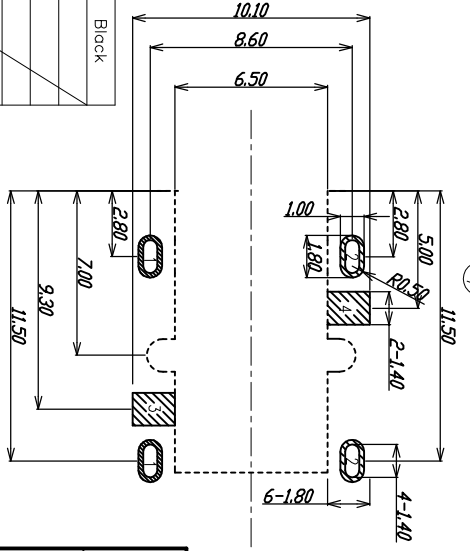

ITEM	PART NAME	QTY	MATERIAL	DESCRIPTION	REMARK
⑦	HOUSING	1	PPA	Gold Flash	Block
⑥	CONTACT F	1	PHOSPHOR BRONZE 0.20T	Gold Flash	
⑤	CONTACT E	1	PHOSPHOR BRONZE 0.20T	Gold Flash	
④	CONTACT D	1	PHOSPHOR BRONZE 0.20T	Gold Flash	
③	CONTACT C	1	PHOSPHOR BRONZE 0.20T	Gold Flash	
②	CONTACT B	1	PHOSPHOR BRONZE 0.20T	Gold Flash	
①	CONTACT A	1	PHOSPHOR BRONZE 0.20T	Gold Flash	

CUSTOMER DRAWING

YTCOON
Dongguan YTCOON Electronics Technology Co., Ltd

GENERAL TOLERANCE	DRAWING	DEVI	TITLE:	PHONE JACK CONNECTOR
X ±0.20	APPROVED		slim 10mm L=12 斜口前后插板中间贴板	
.XX ±0.15	DATE	2013. 06. 05	P/N:	PJ08-06AB05-16
.XXX ±0.10	SCALE	1:1	DRAWING NO.	C-PJ08-16
ANGEL TOLERANCE	UNIT	mm	SHEET	10/2
X ±5°	SCALE	1:1	SHEET	REV
.XX ±2°	SCALE	1:1	SHEET	A
.XXX ±1°	SCALE	1:1	SHEET	A